

PRODUCT SPECIFICATION SHEET

PROMESSA™ SERIES

PART: T100-050

EXTRA DEEP CORNER BASKET KIT

FINISHES: PC, BN, ORB

PERMATILE™ FASTENER SYSTEM WORKS WITH ALL MATERIAL THICKNESSES FROM - 5/32" TO 1/2"
MORTAR BASED INSTALLATION SYSTEM - NO MASTIC OR ORGANIC ADHESIVE ALLOWED!
REFER TO INSTALLATION INSTRUCTIONS BEFORE USE

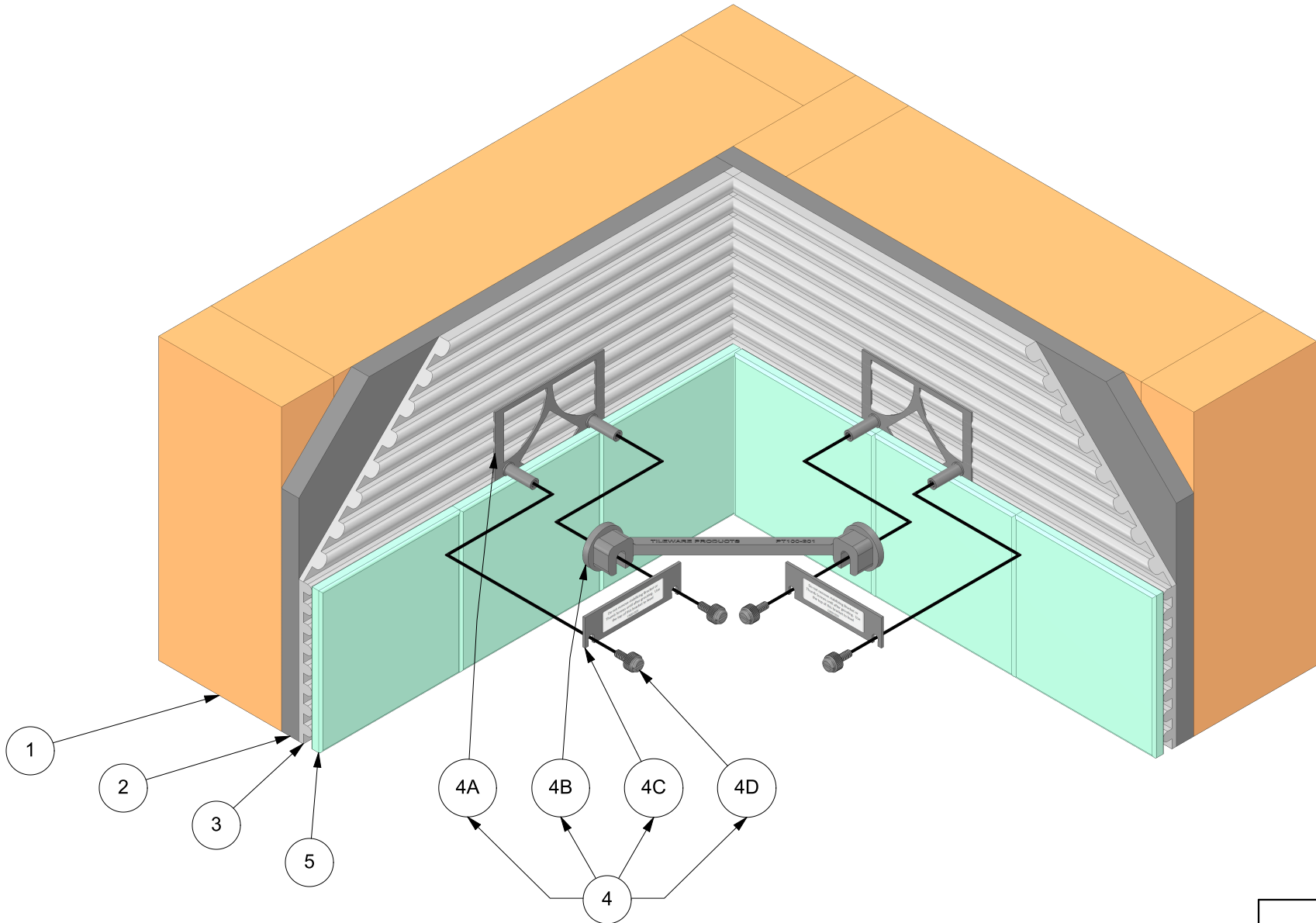

ERP PART #	REFERENCED ABOVE	APPROVALS	DATE
DWG #	307	RLS	10/21/13
SHEET 1 OF 4	SCALE 1:3		
WEIGHT:	2.169 LB	CUBED:	7.831 IN ³

TW-ENG5



TileWare Products
www.tilewareproducts.com

Office (828) 322-9273 Fax (828) 304-1076

PRODUCT SPECIFICATION SHEET

PROMESSA™ SERIES

PART: T100-050

EXTRA DEEP CORNER BASKET KIT

FINISHES: PC, BN, ORB

PERMATILE™ FASTENER SYSTEM WORKS WITH ALL MATERIAL THICKNESSES FROM - 5/32" TO 1/2"
MORTAR BASED INSTALLATION SYSTEM - NO MASTIC OR ORGANIC ADHESIVE ALLOWED!
REFER TO INSTALLATION INSTRUCTIONS BEFORE USE

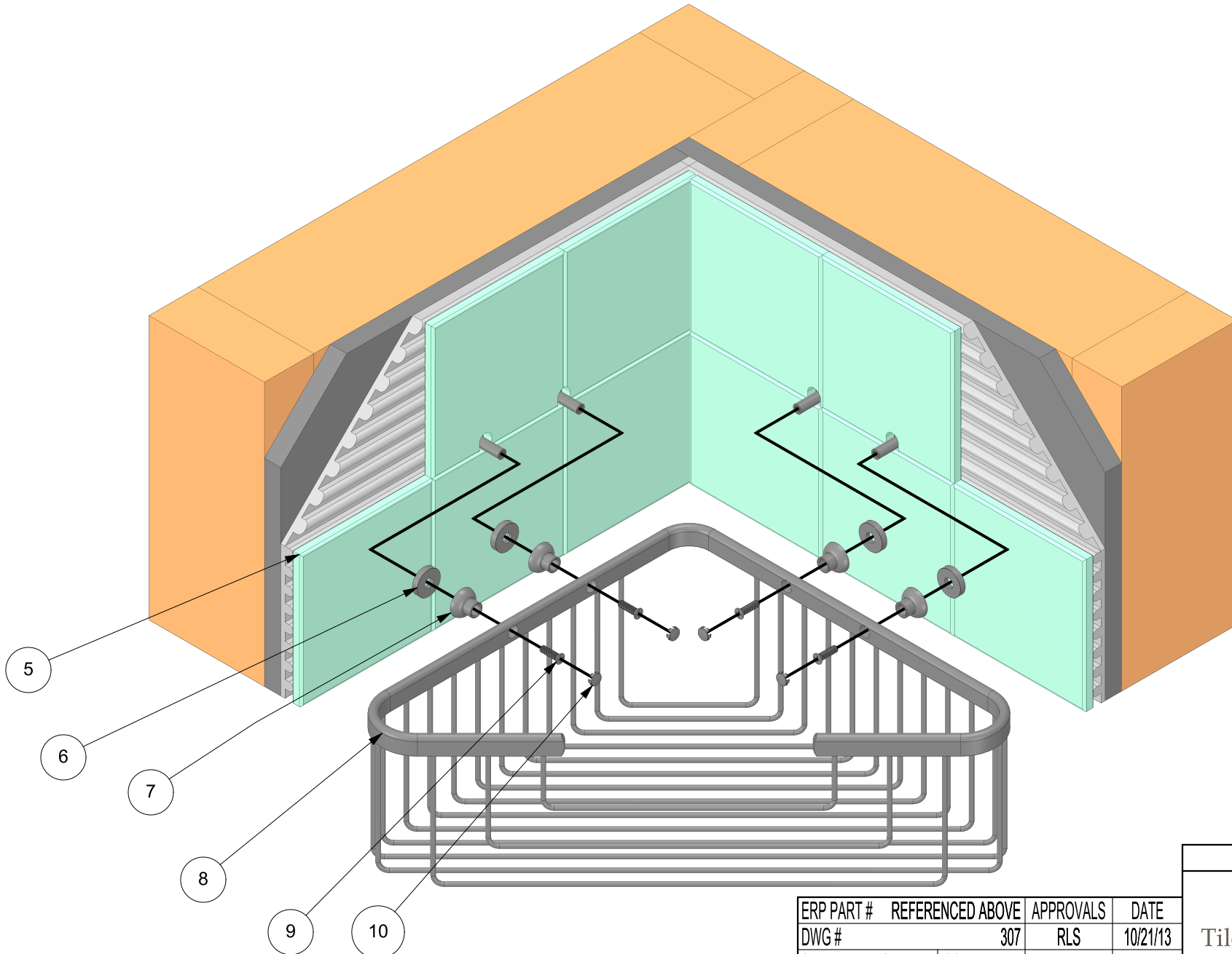

ERP PART #	REFERENCED ABOVE	APPROVALS	DATE
DWG #	307	RLS	10/21/13
SHEET 2 OF 4	SCALE 1:3		
WEIGHT:	2.169 LB	CUBED:	7.831 IN ³

TW-ENG5



TileWare Products
www.tilewareproducts.com

Office (828) 322-9273 Fax (828) 304-1076

PRODUCT SPECIFICATION SHEET

PROMESSA™ SERIES

PART: T100-050

EXTRA DEEP CORNER BASKET KIT

FINISHES: PC, BN, ORB

PERMATILE™ FASTENER SYSTEM WORKS WITH ALL MATERIAL THICKNESSES FROM - 5/32" TO 1/2"
MORTAR BASED INSTALLATION SYSTEM - NO MASTIC OR ORGANIC ADHESIVE ALLOWED!
REFER TO INSTALLATION INSTRUCTIONS BEFORE USE

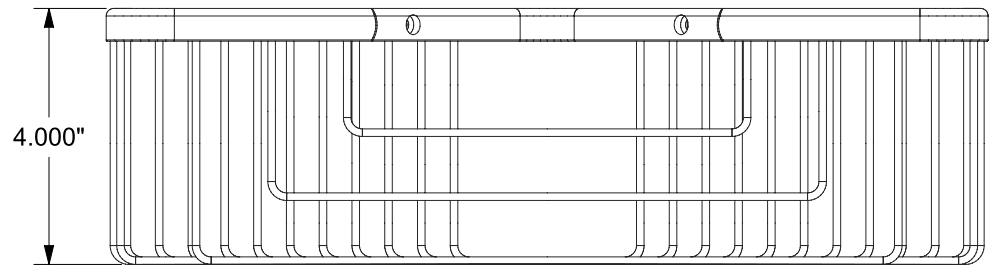
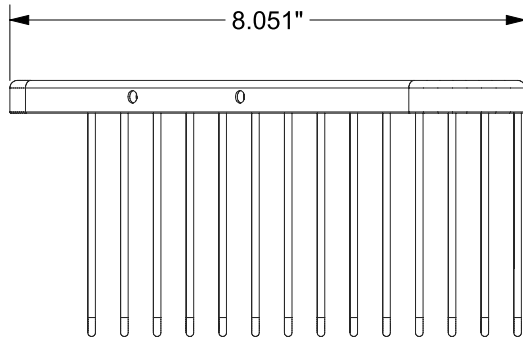
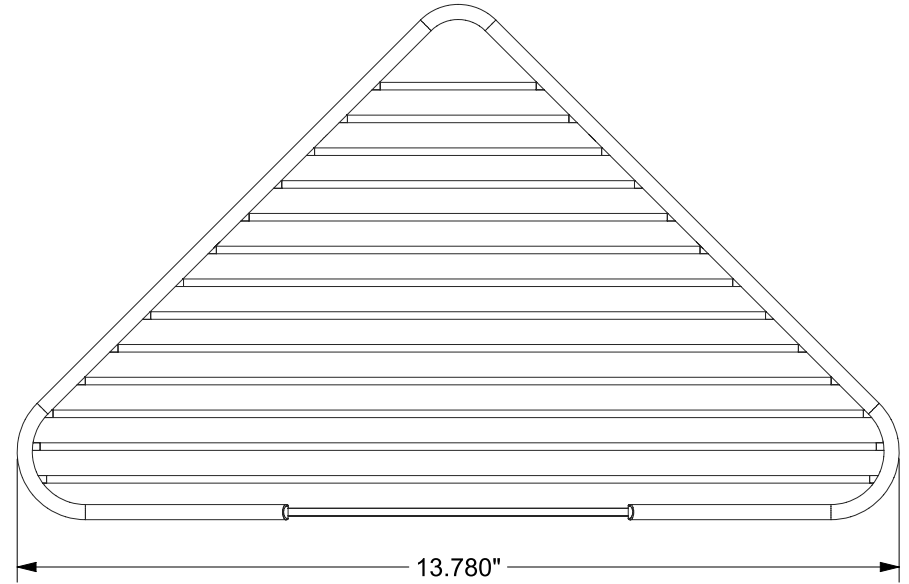
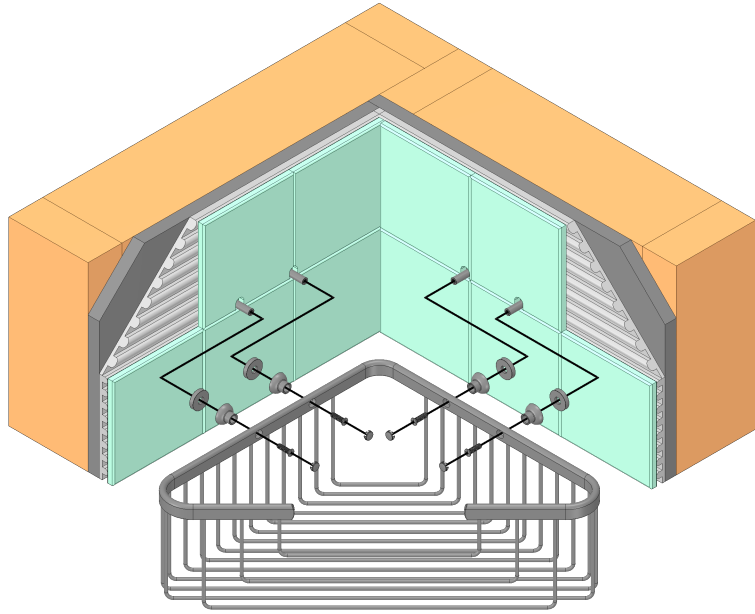

ERP PART #	REFERENCED ABOVE	APPROVALS	DATE
DWG #	307	RLS	10/21/13
SHEET 3 OF 4	SCALE 1:3		
WEIGHT:	2.169 LB	CUBED:	7.831 IN ³

TW-ENG5



TileWare Products
www.tilewareproducts.com

Office (828) 322-9273 Fax (828) 304-1076

PRODUCT SPECIFICATION SHEET











PART: T100-050

PERMATILE™ FASTENER SYSTEM WORKS WITH ALL MATERIAL THICKNESSES FROM - 5/32" TO 1/2"
MORTAR BASED INSTALLATION SYSTEM - NO MASTIC OR ORGANIC ADHESIVE ALLOWED!
REFER TO INSTALLATION INSTRUCTIONS BEFORE USE

PROMESSA™ SERIES

EXTRA DEEP CORNER BASKET KIT

FINISHES: PC, BN, ORB

MODEL IMAGE	REF #	PART #	DESCRIPTION	MATERIAL	QTY	MODEL IMAGE	REF #	PART #	DESCRIPTION	MATERIAL	QTY
	1		STUD WALL PARTITION	WOOD			5		INSTALLED MATERIALS - 5/32" TO 1/2"	CERAMIC, GLASS PORCELAIN, STONE, ETC.	
	2		1/2" TILE BOARD	CEMENT FIBER FOAM			6	C220-020	THIN-TILE WASHER	BRASS	4
	3		1/4" X 3/8" NOTCH TROWEL (ASTM - A118.4 & A118.11)	THIN-SET MORTAR			7	255245	STANDARD FERRULE	BRASS	4
	4	PT100-511	'X' CORNER WALL FASTENER (TILE) (ITEM SOLD ONLY AS A REPLACEMENT PART)	ASSEMBLY	1		8	239250	EXTRA DEEP CORNER BASKET	BRASS	1
	4A	A210-001	SQUARE FASTENER STAMPING WITH 2 WELDED STUDS	STAINLESS STEEL	2		9	A008185	UNC 8-32 X 9/16" PHILLIPS FLAT HEAD SCREW	STAINLESS STEEL	4
	4B	PT100-201	CORNER STABILIZING BRACKET WITH INSERTS (ROUGH - IN COMPONENT, USED ONLY DURING FASTENER INSTALLATION)	PLASTIC	1		10	243168	DECORATIVE PLUG	BRASS	4
	4C	A200-001	STABILIZING BRACKET WITH LABEL (ROUGH - IN COMPONENT, USED ONLY DURING FASTENER INSTALLATION)	CARBON STEEL	2						
	4D	C100-002	THUMB SCREW (ROUGH - IN COMPONENT, USED ONLY DURING FASTENER INSTALLATION)	NYLON	4						

TW-ENG5



TileWare Products

www.tilewareproducts.com

Office (828) 322-9273 Fax (828) 304-1076

ERP PART #	REFERENCED ABOVE	APPROVALS	DATE
DWG #	307	RLS	10/21/13
SHEET 4 OF 4	SCALE N/A		
WEIGHT:	2.169 LB	CUBED:	7.831 IN ³